

# SOFT CLOSING CORNERS HINGES

## CLIP ON SOFT CLOSING 3D CORNERS HINGES

## TCH-14202 SERIES



### • Basic spec

-  Hydraulic buffer
-  Opening angle: 165 °
-  Diameter of hinge cup: 35mm
-  Height of hinge cup 11.5mm
-  Distance of door drilling: 3-7mm
-  Distance of cup holes center: 45mm, 48mm, 52mm
-  Door thickness: 14-21mm
-  Finishing: Nickel plated
-  Main material: Cold-rolled steel
-  Material thickness: zinc alloy - 1.8 - 1.2 mm

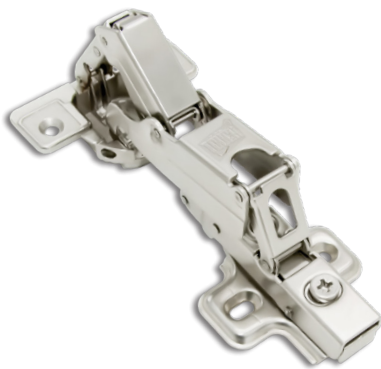

**F**  
Full Overlay

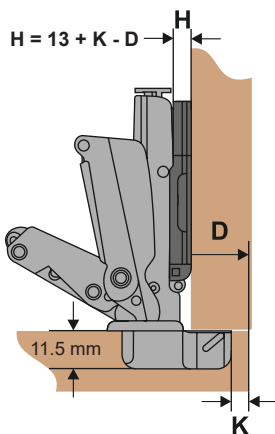

D	H	K	3	4	5	6	7
0	H	K	16	17	18	19	20
3			13	14	15	16	17
5			11	12	13	14	15

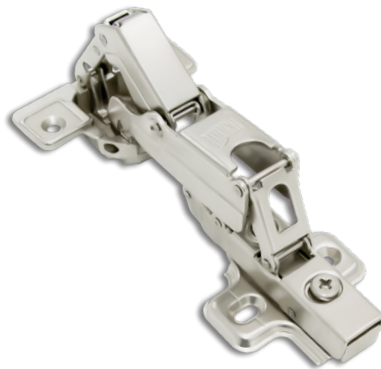

**H**  
Half Overlay

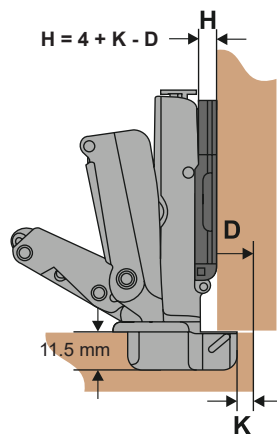

D	H	K	3	4	5	6	7
0	H	K	7	8	9	10	11
3			4	5	6	7	8
5			2	3	4	5	6

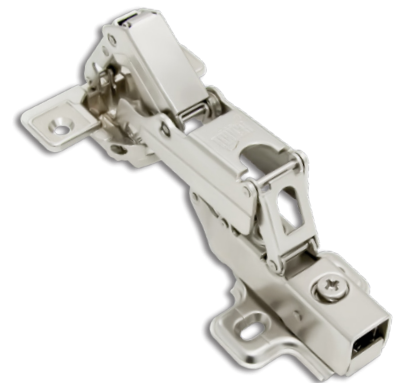

**i**  
Inset

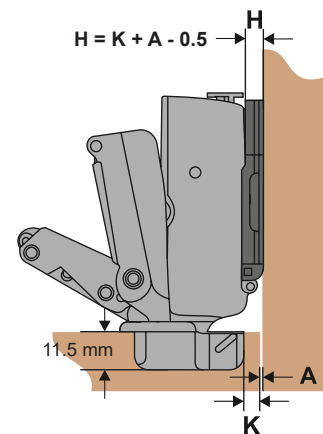

A	H	K	3	4	5	6	7
0	H	K	-2.5	-1.5	-0.5	0.5	1.5
3			-5.5	-4.5	-3.5	-2.5	-1.5
5			-7.5	-6.5	-5.5	-4.5	-3.5

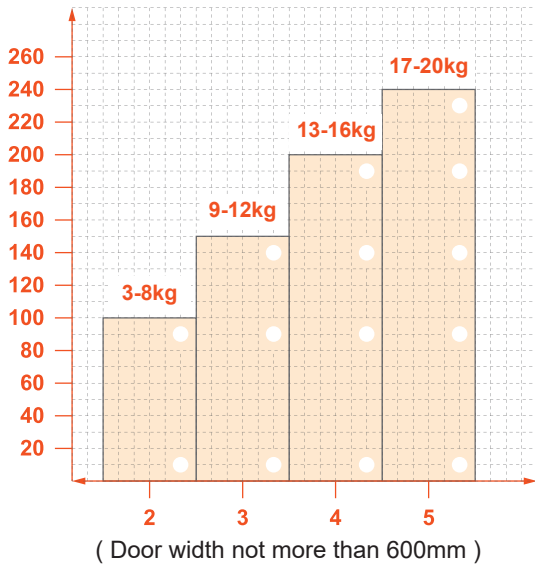

● **Application**

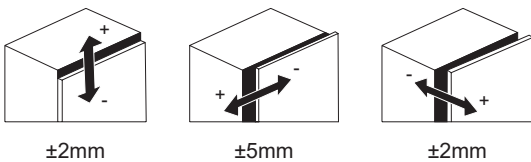
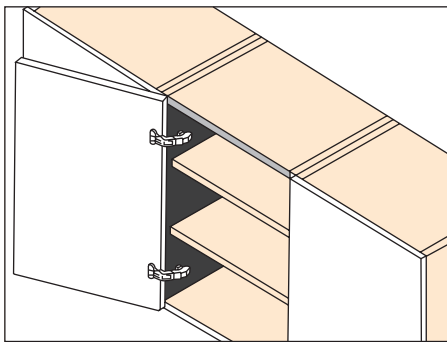

● **Dimension of hinge cup**

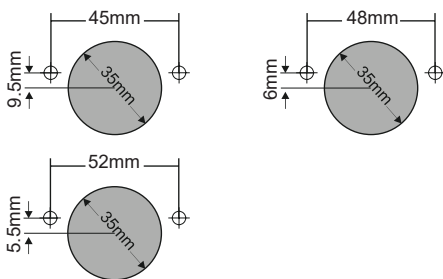

● **Mounting-plate**

**B02**

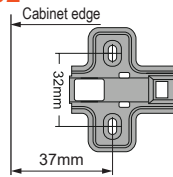

Hole Type	H Value	Type
Two holes	H=0 / 3 / 5	Clip on

**B03**

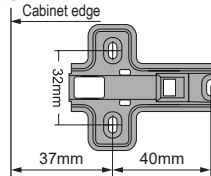

Hole Type	H Value	Type
Three holes	H=0 / 3 / 5	Clip on

**B04**

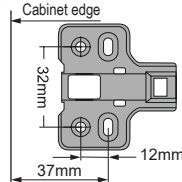

Hole Type	H Value	Type
Four holes	H=0 / 3 / 5	Clip on

**F02**

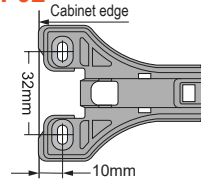

Hole Type	H Value	Type
Two holes	H=0 / 3 / 5	Clip on

**F04**

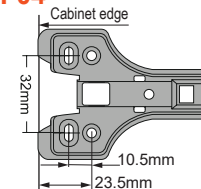

Hole Type	H Value	Type
Four holes	H=0 / 3 / 5	Clip on

**D12**

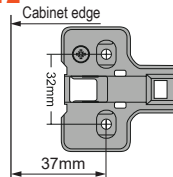

Hole Type	H Value	Type
Two holes	H=0 / 3 / 5	Clip on

**D02**

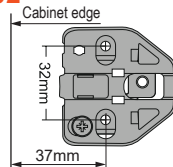

Hole Type	H Value	Type
Two holes	H=0 / 3 / 5	Clip on

● **Alternative screw types**

