

● **Application**

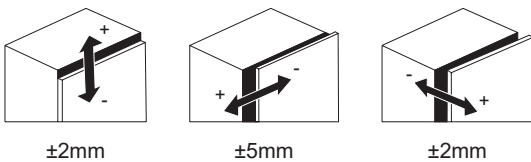

● **Dimension of hinge cup**

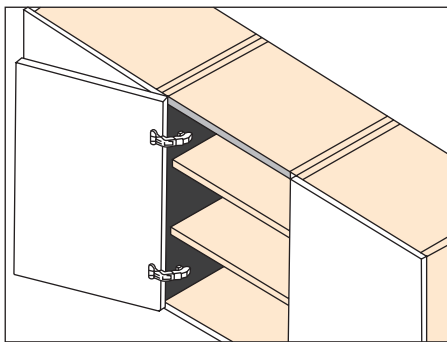
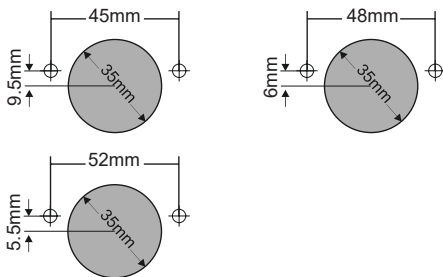

● **Mounting-plate**

B02

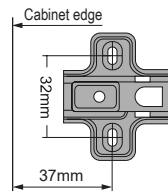

Hole Type	H Value	Type
Two holes	H=0 / 2 / 4	Clip on

B04

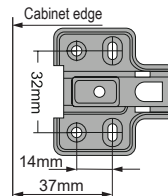

Hole Type	H Value	Type
Four holes	H=0 / 2 / 4	Clip on

FZ02

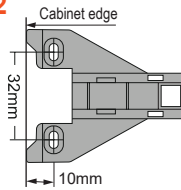

Hole Type	H Value	Type
Two holes	H=0 / 2 / 4	Clip on

D12

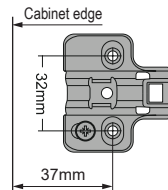

Hole Type	H Value	Type
Two holes	H=0 / 2 / 4	Clip on

● **Alternative screw types**

