



• Basic spec

- Invisible
- Length : 300mm - 550mm
- height : 228mm
- Thickness of bottom & back panels : 16mm
- Drawer adjustment : Up & Down ± 2 mm, left and right ± 1.5 mm
- Finishing of slides : Galvanized steel
- Finishing of boards : Various colors
- Material : 1.0 - 1.5 - 1.8 mm cold-rolled steel
- Loading : 35 kg / 18"
- Smooth and silent movement
- Soft closing

• **Space required**

SKW : Internal cabinet width

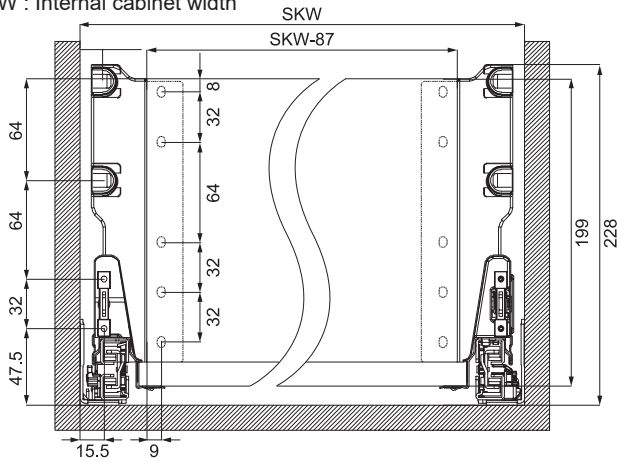

• **Installation size**

LT : Internal cabinet depth
NL : Normal size

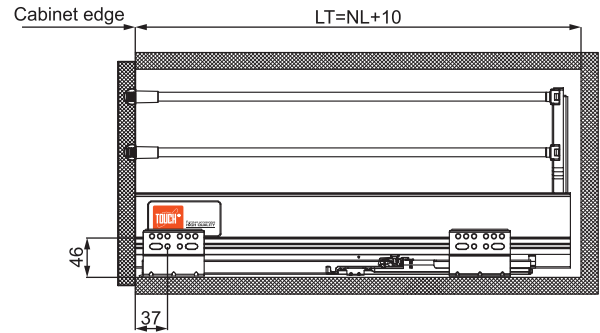

• **Drawer board dimensions**

LW : Internal cabinet width
NL : Normal size

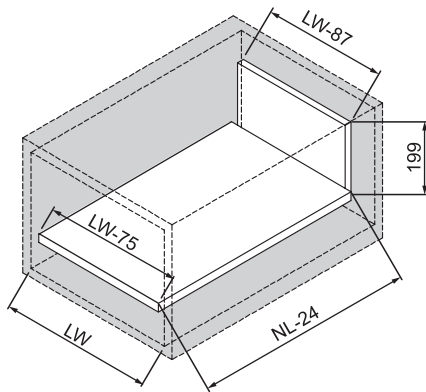

• **Adjustment mechanism**

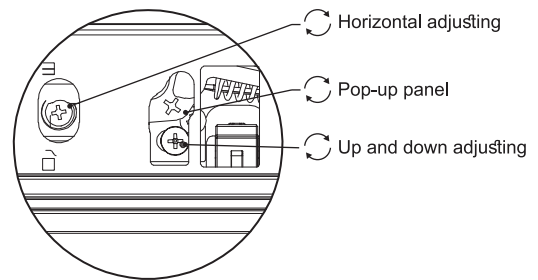

• **Specification**

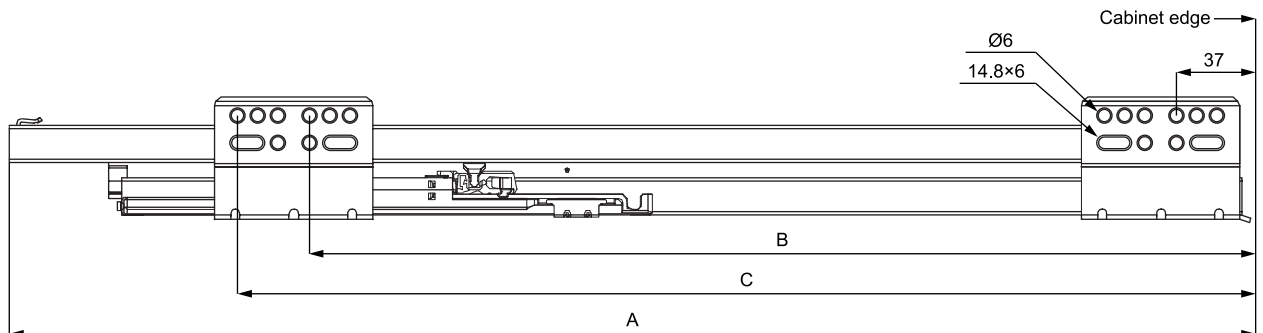

Item No.	Size	Extension length	A	B	C
TCH-24101300	12" 300mm	284	300	192	224
TCH-24101350	14" 350mm	334	350	192	224
TCH-24101400	16" 400mm	384	400	256	288
TCH-24101450	18" 450mm	434	450	288	320
TCH-24101500	20" 500mm	484	500	352	384
TCH-24101550	22" 550mm	534	550	384	416